

# COUNTERTOP

## iSpring RCD100HCW / RCD100THCW Countertop Hot/Cold Reverse Osmosis Dispenser

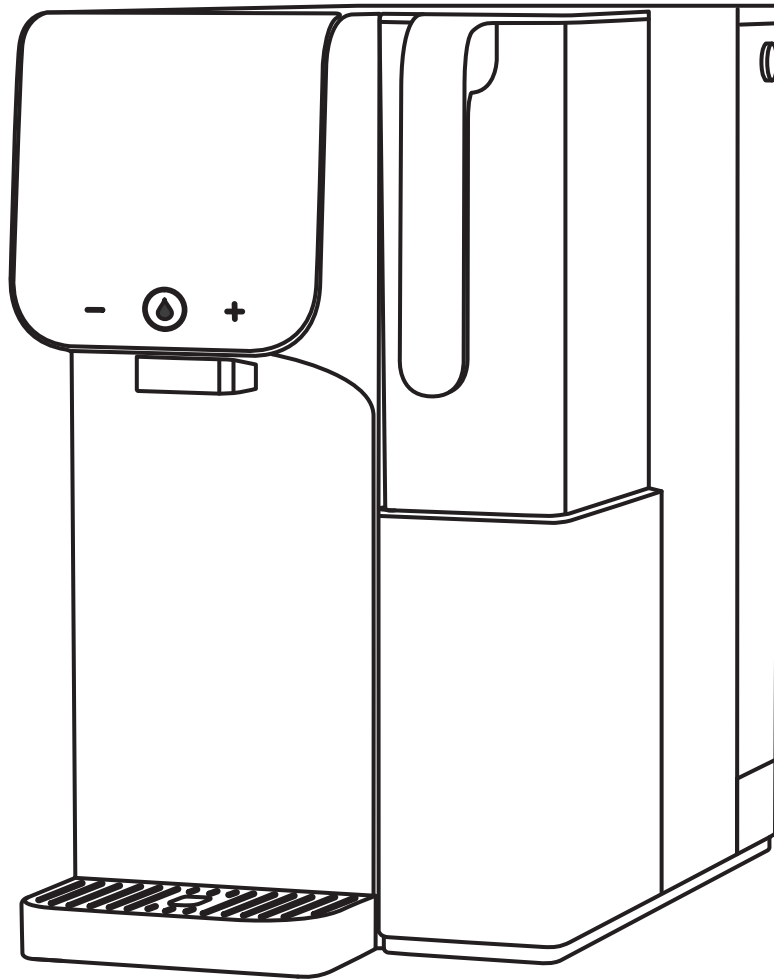

Model: RCD100HCW/RCD100THCW

## Installation Instructions & User Manual

Ver. 09/2025



**iSpring** Water Systems

Support  
&  
Warranty



Copyright ©2007-2025 ISPRING WATER SYSTEMS, LLC. All rights reserved.





***We stand behind our products***

Since 2007, iSpring has been committed to delivering safe and clean water solutions to families and businesses worldwide. We provide a wide range of residential and commercial water filtration systems designed to purify your water, ensuring that you and your family enjoy pure, healthy, and great-tasting water every day.

At iSpring, we strive to develop products to the highest standards and aim to make excellent drinking water accessible for all households. With affordable pricing, reliable quality, prompt delivery, and top-notch customer service, we hope to assist in bringing you great water for years to come.



## Prior to Installation

Read this instruction manual carefully prior to installation.  
Keep this manual readily available for future reference.

### Table of Contents

User Information.....	05
Packing List.....	06
Product Features.....	07
Display and Touch Screen Operations.....	08
Installation and Replacement Instructions.....	12
Preparation .....	12
Initial system startup.....	12
Filter installation and replacement.....	14
Filter life indicator reset .....	15
Filter replacement and service schedule .....	15
Model Filter Package.....	15
How to clean the 1st stage filter? .....	16
Troubleshooting .....	16

## User Information

The user must adhere to the installation specifications described in this Product Installation and Operation Manual (the "instruction manual"). iSpring is not responsible for damage, loss, or injury resulting from neglect, improper maintenance, or unauthorized modification of products.

- This product is designed for residential use only. Contact iSpring customer service for non-residential applications.
- This system must be installed indoors. The installation location should be well-ventilated and protected against wind and rain. Avoid direct sunlight and radiation from any heat sources.
- The operating temperature range is 41–100°F (5–38°C). This water filtration system is NOT designed for HOT water. If the water temperature or ambient temperature falls below 41°F, immediately shut off the inline water supply and drain the remaining water from the system.
- In case of malfunction due to damage or failure of the power supply system, unplug the system immediately and contact iSpring customer service for guidance.
- Ensure there is proper space around the system, and apply no external force to the system or its connecting pipes.
- Use only authorized iSpring parts and filters. Using unauthorized or aftermarket components will void the product warranty.
- Unauthorized modification and disassembly are strictly prohibited and will void the warranty.
- It is recommended that users check external fittings and connections regularly to ensure all components are secure and operating properly.
- This system is not intended for use by persons (including children) with reduced physical, sensory, or mental capabilities or lack of experience and knowledge unless they have been given supervision or instruction concerning the use of the appliance by a person responsible for their safety. Children should be supervised to ensure that they do not tamper with the appliance.
- Never touch the power cord connector when your hands are wet, as this may result in electric shock.
- Product installation and use must strictly comply with the requirements of this manual. Perform no operations on the product without reading and understanding the contents of this manual.
- Activation of this product indicates that the owner has carefully read, understood, and accepted the contents of this manual, including the safety notices and instructions.
- Do not put heavy objects on the machine; otherwise, it will damage its accessories, causing a leakage problem.
- Please cut off the power if you do not use the machine for more than 24 hours.

- Before moving the machine, please clear the source water tank and pure water pitcher, dispense the room temperature water, and wait until it can not dispense water.
- When you use it for the first time or again after the power is off, you need to dispense a cup of room temperature water first, and then you can get hot water.

## Packing List

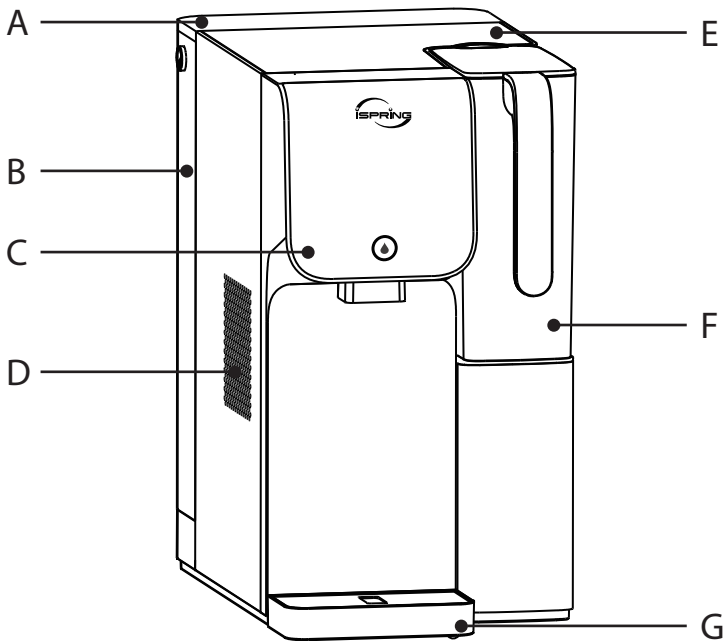

<b>A</b>	Source Water Tank Cap
<b>B</b>	Source Water Tank
<b>C</b>	Display
<b>D</b>	Cooling Vent
<b>E</b>	Filter Cap
<b>F</b>	Pure Water Pitcher
<b>G</b>	Removable Drip Tray

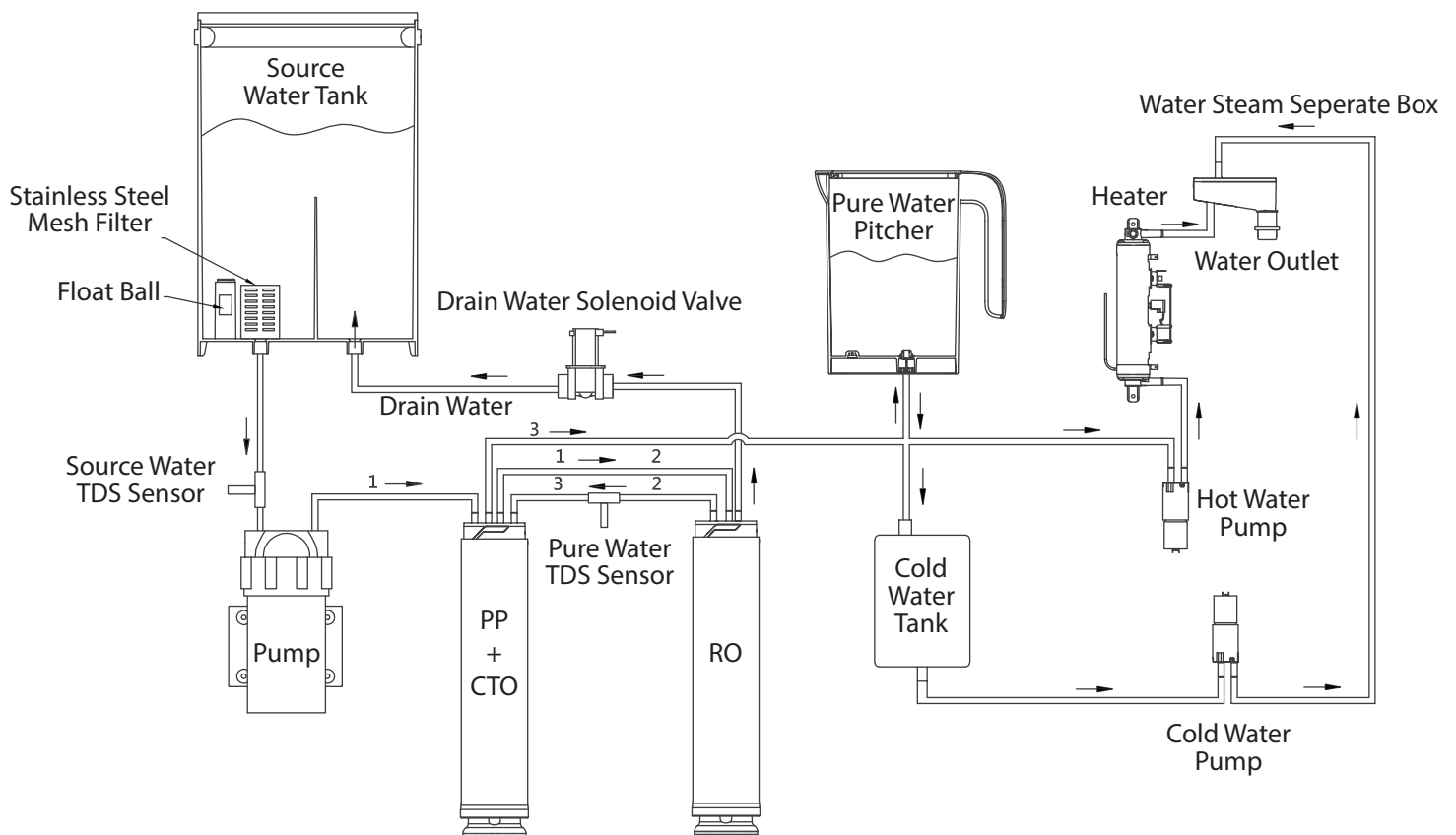







## Product Features

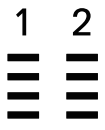

Parameter	Specification
Incoming Water Temperature	41–100°F (5–38°C)
Applicable Water Source	Municipal Water
Pure Water Production	Up to 0.07 GPM (0.26 L/min.)
Source Water Tank Volume	1.32 Gallon (5 L)
Pure Water Pitcher Volume	0.42 Gallon (1.6 L)
Cold Water Tank Volume	0.13 Gallon (0.5 L)
Rated Power	1500 W
Heating Power	1380 W
Cooling Power	65 W
Rated Voltage	110 V
Rated Frequency	60 Hz
Water Dispensing temperature (°F / °C)	50 / 80 / 115 / 140 / 160 / 170 / 185 / 195 / 210 °F 10 / 27 / 46 / 60 / 71 / 85 / 91 / 99 °C
Water Dispensing Volume (fl oz)	3 / 4 / 6 / 8 / 10 / 17 ±10%
Product Dimensions (H*W*D)	16.3*9.2*16.7 (inch) / 414*233*425 (mm)

- Do not use this system with water that is microbiologically unsafe or inadequately disinfected.
- Performance data was tested under standard laboratory conditions; actual performance may vary.
- This system is designed to be used on cold water supply ONLY and to be kept away from freezing environments.
- Choking hazard: Small parts are included in the package. Please keep the package out of the reach of small children at ALL times.
- The actual concentration of TDS will be displayed after 2 minutes of power on.
- 50°F cold water is the lowest temperature that can be reached after cooling the cold water tank. The water temperature will gradually rise after dispensing out, and the actual dispensed water temperature will be slightly higher.
- Version changes or corrections to the manual will not be reissued or notified separately. Please download it from the iSpring official website or contact Customer Service.

# Display and Touch Screen Operations



Buttons and Indicators	Operations and Instructions
 <p><b>Water Temperature and Volume</b></p>	<p>Displays set temperatures and volumes. It shows temperature during idle or dispensing states. While setting, "°F" and "oz" light up with their respective temperature and volume values. After setting the volume, it reverts to the temperature display in 5 seconds.</p>
 <p><b>TDS in Source Water Tank</b></p>	<p>Displays the TDS concentration in the source water tank. The maximum value is 999 ppm. If it exceeds 1,000 ppm, the "<b>Source Water Tank Warning</b>" indicator will prompt.</p>
 <p><b>Pure Water TDS</b></p>	<p>Displays the TDS concentration of the pure water. The maximum value is 100 ppm.</p>
 <p><b>Filter Life Indicator</b></p>	<p>The filter life indicator displays the lifespan of two filters: "1" for the FPT100 composite filter and "2" for the MCD100HC RO membrane. It features a 4-bar display that diminishes gradually with use and turns off completely when the filter life falls below 5%. When a filter reaches the end of its life, the corresponding indicator "1" or "2" will flash (once per second) accompanied by a 30-second beep. The flashing "1" or "2" will continue until reset.</p>
 <p><b>RESET</b></p> <p><b>Filter Life Reset Button</b></p>	<p>The "<b>RESET</b>" button typically remains unlit but activates when the filter reaches the end of its life. The "<b>RESET</b>" button lights up if "1" or "2" flashes on the display. First, unlock the system by pressing the "<b>LOCK</b>" button. Then, press and hold the "<b>RESET</b>" button for 3 seconds until it flashes, indicating entry into filter reset mode with the filter life bar flashing. Press the "<b>RESET</b>" button again to select the filter needing reset. Press and hold the "<b>RESET</b>" button for 3 seconds to complete the reset. The filter life indicator will then reset.</p> <p>Note: The filter life can be reset before its end. After resetting, there will be a 2-second beep, and the display will show a full filter life bar.</p>
 <p><b>LOCK</b></p> <p><b>Lock Button</b></p>	<p>The "<b>LOCK</b>" button lights up in red during inactivity. It locks for dispensing water temperatures above room temperature (80°F). Press the "<b>LOCK</b>" button to unlock; the light goes out, indicating that water at higher temperatures can now be dispensed. If there's no operation, it automatically locks after 10 seconds, and the light remains on.</p>
 <p><b>Flush Indicator</b></p>	<p>Reverse osmosis membrane flush indicator. No water will be produced during flushing. The system will flush for 10 seconds when the source water tank cover is opened/closed, and the water has been changed. The system will also flush for 120 seconds when powered on for the first time or powered off and on again.</p> <p>Note: Flushing protects the reverse osmosis membrane and extends the life of the filters.</p>
<p><b>UV</b></p> <p><b>UV Indicator</b></p>	<p>The UV Indicator remains on if cold and hot water flows through the UV unit.</p>
 <p><b>Source Water Tank Warning</b></p>	<p>Source water tank cap/water change reminder indicator. When the source water tank cap is open; the indicator lights up. When the source water tank is short of water, the indicator flashes with 4 beeps. When the TDS in source water tank exceeds 1,000 ppm, the indicator flashes with 6 beeps.</p>

Buttons and Indicators	Operations and Instructions
 <p data-bbox="108 282 472 349"><b>Pure Water Pitcher Water Shortage Indicator</b></p>	<p data-bbox="515 174 1506 309">The water shortage indicator for the pure water pitcher remains off during inactivity. When the pure water pitcher runs out of water, the indicator turns red and emits 2 beeps. If the pure water pitcher cannot be detected, the indicator flashes accompanied by 2 beeps.</p>
 <p data-bbox="124 468 456 535"><b>Cold Water Tank Water Shortage Indicator</b></p>	<p data-bbox="515 369 1506 465">The cold water tank water shortage indicator remains off during inactivity. When the cold water tank is out of water, the indicator stays on with 2 beeps.</p>
 <p data-bbox="180 629 400 707"><b>COOLING</b> <b>Cooling Button</b></p>	<p data-bbox="515 548 1506 719">The "<b>COOLING</b>" button lights up solid white when inactive. The cooling function is preset to off, indicated by a solid white light. Press this button to activate the cooling function; the indicator will turn blue. During cooling, the blue light flashes every 2 seconds and remains solid once the water reaches the desired temperature.</p>
 <p data-bbox="252 831 335 864"><b>VOL</b></p> <p data-bbox="97 887 483 931"><b>Dispensing Volume Button</b></p>	<p data-bbox="515 739 1506 943">The water dispensing volume selection button lights up white when inactive. It offers six volume options: 3, 4, 6, 8, 10, and 17 oz, with the default value upon powering on being 6 oz. When the temperature is displayed, and the "<b>VOL</b>" button is pressed for the first time, the display switches to the previously set water dispensing volume. Press the button again to switch between the options.</p>
 <p data-bbox="236 1055 341 1088"><b>TEMP</b></p> <p data-bbox="116 1111 464 1178"><b>Dispensing Temperature Button</b></p>	<p data-bbox="515 963 1506 1189">The water dispensing temperature selection button lights up white when inactive. There are nine temperature options available: 50, 80, 115, 140, 160, 170, 185, 195, and 210°F, with the default setting upon powering on being 80°F. Press the "<b>TEMP</b>" button to select your desired water temperature. To set the dispensing temperature above room temperature (80°F), you must unlock the "<b>LOCK</b>" before dispensing. The system will remember your previous water dispensing temperature setting.</p>
 <p data-bbox="252 1312 325 1346"><b>TEA</b></p> <p data-bbox="89 1357 489 1402"><b>Temperature for Tea Button</b></p>	<p data-bbox="515 1209 1506 1413">The "<b>TEA</b>" temperature button lights up solid white when inactive. When pressed, the light turns red, and the temperature displays 210°F. Before dispensing water, you must press the "<b>LOCK</b>" button to unlock the system. Then, press the "<b>Dispense</b>" button to get water. The button reverts to solid white 5 seconds after dispensing is completed or if there is no operation for 5 seconds.</p>
 <p data-bbox="225 1525 352 1559"><b>FORMULA</b></p> <p data-bbox="108 1559 472 1637"><b>Temperature for Formula Button</b></p>	<p data-bbox="515 1433 1506 1637">The "<b>FORMULA</b>" temperature button lights up solid white when inactive. The light turns red when this button is pressed, and the temperature displays 115°F. Before dispensing water, you must press the "<b>LOCK</b>" button to unlock the system. Then, you can press the "<b>Dispense</b>" button to get water. The button reverts to solid white 5 seconds after dispensing is completed or if there is no operation for 5 seconds.</p>
 <p data-bbox="201 1738 376 1771"><b>ROOM TEMP</b></p> <p data-bbox="97 1783 483 1827"><b>Room Temperature Button</b></p>	<p data-bbox="515 1657 1506 1816">The "<b>ROOM TEMP</b>" button lights up solid white when inactive. When pressed, the light turns red, and the temperature displays 80°F. You can directly press the "<b>Dispense</b>" button to get water. The button reverts to solid white 5 seconds after the water dispensing is completed or if there is no operation for 5 seconds.</p>
 <p data-bbox="236 1917 341 1962"><b>COLD</b></p> <p data-bbox="113 1973 467 2040"><b>Cold Water Temperature Button</b></p>	<p data-bbox="515 1836 1506 2007">The "<b>COLD</b>" temperature button lights up solid white when inactive. When pressed, the light turns red, and the temperature displays 50°F. You can directly press the "<b>Dispense</b>" button to get water. The button reverts to solid white 5 seconds after the water dispensing is completed or if there is no operation for 5 seconds.</p>

Buttons and Indicators	Operations and Instructions
<p style="text-align: center;">— +</p> <p style="text-align: center;"><b>Increase / Decrease Buttons</b></p>	<p>The water dispensing temperature selection buttons light up solid white when inactive. Press the "+" button to increase and the "-" button to decrease the temperature. There are nine temperature options that display in a loop: 50°F, 80°F, 115°F, 140°F, 160°F, 170°F, 185°F, 195°F, and 210°F.</p>
<p style="text-align: center;"></p> <p style="text-align: center;"><b>Dispense Button</b></p>	<p>The water dispensing button lights up and dims sequentially in sleep mode, lights up in solid blue when waiting for an operation, and flashes blue when water is dispensing.</p> <p>Please press the "<b>LOCK</b>" button before getting water above room temperature (80°F). If the water temperature and volume are not set, the water will be dispensed according to the previous setting.</p> <p>When the water temperature is set as cold or room temperature, water can be dispensed without pressing the "<b>LOCK</b>" button.</p>
<p style="text-align: center;"><b>IT IS STRONGLY RECOMMENDED TO FOLLOW THE INDICATOR ON FILTER REPLACEMENTS/SERVICE, OR THE WARRANTY MAY BE VOIDED.</b></p>	

**Other notes:**

- The system will flush for 120 seconds every time the power is off and on again.
- The system will flush for 10 seconds every time after the source water tank has been filled.
- Sleep Mode: The system will automatically enter sleep mode after 5 minutes of inactivity. All displays/lights will be turned off. Press any button to exit sleep mode.
- Silence Mode: After powering on the machine, regardless of the "**LOCK**" button's lock status, press and hold both the "**LOCK**" and "**COOLING**" buttons simultaneously for 5 seconds. This will trigger a long beep, turning off the beep that accompanies button pressing. To reactivate the beep, press and hold the "**LOCK**" and "**COOLING**" buttons again for 5 seconds; a long beep will confirm the beep function is turned back on.
- When the system is powered off and on again, it must dispense room-temperature water for 8 seconds before dispensing hot water.
- The system needs to dispense room temperature water for 5 seconds before dispensing hot water after the pure water pitcher water shortage is on and off.
- Touching any key during the water dispensing can stop the water from dispensing. Each time the water stops dispensing, the buzzer will beep for 2 seconds to indicate that the water dispensing is completed.

# Installation and Replacement Instructions

## Preparation:

1. Place the system on a stable, leveled surface and remove the filter packaging. Please remove the drip tray from the packaging and place it below the water dispensing outlet.
2. Open the source water tank cap and lift the tank. Rinse the tank and the pure water pitcher thoroughly.
3. Please refer to the "**Filter installation and replacement**" instructions for filter installation.
4. Place the 1st stage FNF100 stainless steel mesh filter onto the slot at the bottom of the tank on the left side.
5. Fill the source water tank with an appropriate amount of water. Do not exceed the maximum water mark.
6. Put the source water tank and the empty pure water pitcher into the system, close the top cover cap, and then plug in the power.

## Initial system startup:

1. The system will perform an initial flush lasting 120 seconds upon first use. During this flushing process, the flush indicator and filter "1" and "2" indicators will illuminate, and the display will indicate 0% to signify the initial rinsing phase. After the 2-minute flush is completed, the system will begin producing water.  
Note: During flushing, except for the "**Dispense**" button, "**ROOM TEMP**" button, and temperature for "**TEA**" button, all other buttons are lit off and cannot be operated.
  2. When water production begins, the "**water-producing**" indicator will be illuminated, and the water volume in the pure water pitcher will gradually increase until it's full. Simultaneously, the rinsing progress display will incrementally rise. Once the water reaches its maximum capacity, the rinsing progress will cease increasing. At this point, empty both the pure water pitcher and the cold-water tank by pressing the dispense button. When the system resumes water production, the rinsing progress will also resume and continue to increase. Repeat the procedure for rinsing. If the source water tank runs low on water during rinsing, please first remove any remaining water and then refill the source tank. Wait until the cleaning progress reaches 100% to complete the startup process.
- The initial rinsing process takes a long time, so please be patient. During the flushing and water production, the display will show the progress increasing by 1 every 20 seconds of water production. Once it reaches 25, the filter life bar will gradually light up from the bottom to the top. When the progress reaches 100, the filter life bar will be fully lit, and water production will stop. After the water-producing indicator turns off for 1 second, the progress will indicate 100%, and the filter life indicator will flash, signaling the completion of the initial rinsing process. Press any key to return to the regular status.

- The initial rinsing process is designed to clean the filter and pipeline. During this process, you may notice the presence of fine activated carbon particles or bubbles in the rinse water. This is a normal occurrence. Please continue rinsing repeatedly until the water runs clear. When using the filter for the first time, please be sure to rinse the filter several times. The FPCA100 is a composite filter containing activated carbon. There will be black water when flushing for the first time. This is normal when finer activated carbon particles are flushed out with the water flow. After rinsing for the first time, it can be used normally when there is no black water.
- Brand-new RO membranes come with a preservation solution between them. When using them for the first time, it's essential to rinse this solution with water. If the rinse is incomplete and the water is left standing in the pitcher for an extended period, you may notice that the pitcher's walls become slightly sticky. This stickiness is due to the presence of the reverse osmosis membrane preservation solution.

**!** **Note:**

- Rinse the tank and replace the water if not used for more than 24 hours.
- Do not fill the tank with any liquid other than water.
- The system has been tested and checked. There might be some residual water in the pipeline. This is normal and is not a quality issue. Please feel free to use it.
- If you do not drink the water from the cold water tank regularly, it is recommended to dispense about 17 oz of water from the cold water tank every two days to avoid odors.

## Filter installation and replacement:

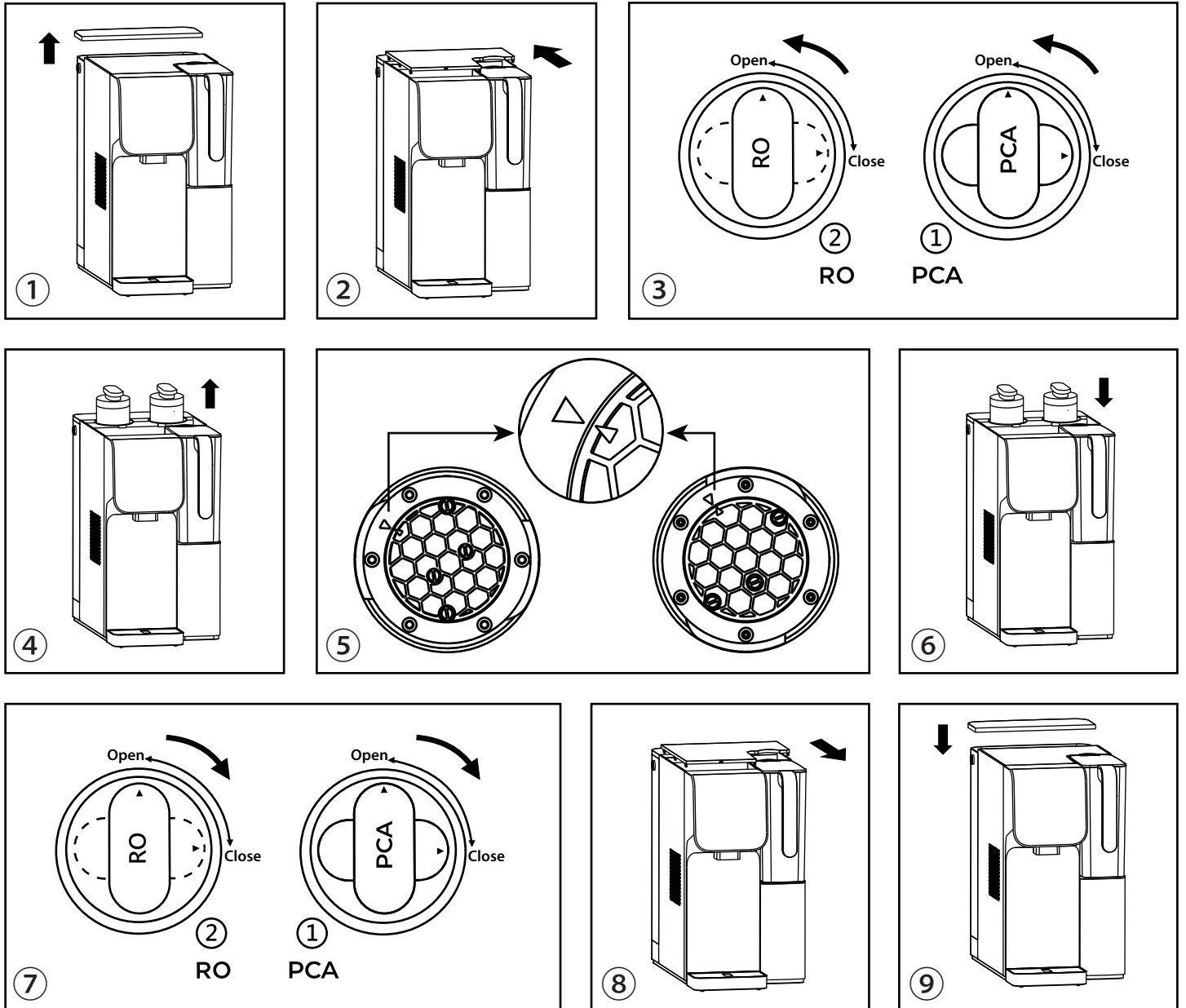

1. Remove the source water tank cover cap.
2. Flatly push the filter cover back. When the cover is pushed out of the slot, you can lift it up.
3. Turn off the power by unplugging the dispenser.
4. According to the direction on the panel, hold and turn the filter handle counterclockwise to the "**Release**" position to release the filter.
5. Lift and remove the used filter.
6. Remove the new filter's plastic wrap and dust cover, and confirm that the arrow on the filter rotator and the arrow on the filter body are aligned. If they are not aligned, please turn the rotator to align them.
7. Align the mark on the filter handle with the "**Release**" position and insert the new filter into the corresponding slot.
8. According to the direction on the panel, hold and turn the filter handle clockwise to the "**Lock**" position to secure the filter.

9. After securing the filter, insert the filter cover into the groove, push it back toward the display, and cover the source water tank cap.
10. Turn the power back on.

### Filter life indicator reset:

1. Press the "**LOCK**" button first to unlock the system.
2. Press and hold the "**RESET**" button for 3 seconds to enter the filter life reset mode.
3. Press the "**RESET**" button again to choose the filter that has been replaced.
4. Press and hold the "**RESET**" button for 3 seconds to reset the filter life indicator.
5. The system is now ready to be used. Please use the following information to service and replace the filters based on the recommended schedule:

### Filter replacement and service schedule

- All iSpring Water Systems are designed with ease of use and low maintenance in mind. The system will work properly for years if the filter cartridges are changed on the suggested schedule. See the chart below for the filter model numbers for your system. The filters can be found on [ispringwater.com](http://ispringwater.com), Amazon, or HomeDepot.com.
- There are two ways to calculate the filter lifespan of the system. One is by the time the water flows, and the other is by the system's power-on time. Both of them are calculated independently. The filter life indicator will blink, whichever comes first.
- The filter life calculated by the time of water flowing will detect the source water TDS and convert it to the lifespan according to different TDS.

Stage No.	Filter Model#	Content	Lifespan by Power-on Time	Lifespan by Water Flowing Time Source Water TDS (ppm)		
				< 300	300 ~ 800	> 800
1	FNF100	Stainless Steel Filter	Clean at least every 3 weeks with a soft brush or replace when needed			
2	FPT100	Composite Filter	Up to 12 months	130 hr.	97.5 hr.	65 hr.
3	FPCA100	Composite AK Filter	Up to 12 months	130 hr.	97.5 hr.	65 hr.
4	MCD100HCG	RO Membrane	Up to 24 months	260 hr.	195 hr.	130 hr.

The filters are highly suggested to be cleaned or replaced when they reach their recommended replacement cycle. However, the actual lifespan of filters may vary depending on the source water quality and frequency of usage. Please follow the filter life indicator and replace the filter on time.

### Model Filter Package

Model Name/Filter Name	FNF100	FPT100	FPCA100	MCD100HCG
RCD100HCW	√		√	√
RCD100THCW	√	√		√

## How to clean the 1st stage filter?

Every 3 weeks, follow these steps:

1. Open the source water tank cap.
2. Take out the filter.
3. Carefully clean the filter using a brush.
4. Put the filter back in place after cleaning is complete

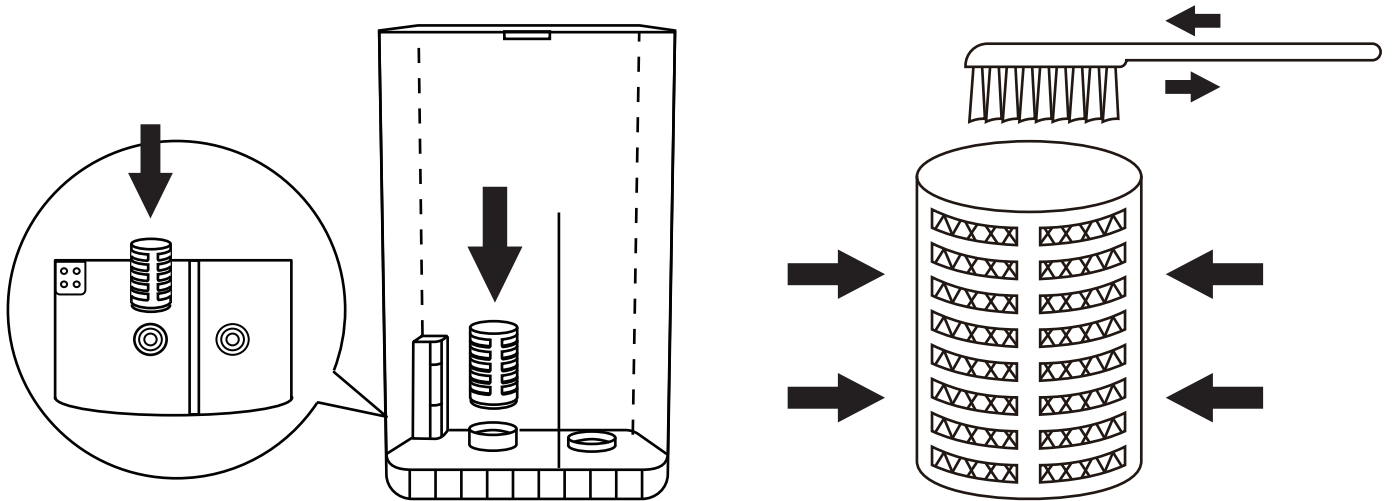

**Note:** Depending on the inlet water quality, the 1st stage filter may need to be replaced every certain period.

## Troubleshooting

Issue	Possible Reason	Solution
The machine is not powered on.	a. No power?	Check if the system is plugged in.
The display does not light up.	b. Is the power plugged in correctly?	
No hot water.	a. The display shows that the pure water pitcher is short of water b. When powered on, the system will dispense water at room temperature for 8 seconds.	a. Wait for the system to complete pure water production, and the pure water pitcher water shortage indicator light goes out. b. Get an extra cup of water.
There is water in the source water tank, but the display shows a water shortage.	TDS shows 999	Replace the water in the source water tank

## Error Codes

Code	Possible Reason	Solution
<b>E1</b>	Continuous water production for 30 minutes.	Reconnect to the power supply. If <b>E1</b> is still displayed after re-powering on, don't hesitate to contact iSpring.
<b>E2</b>	The heater is heating without water.	Set room temperature water to dispense water. If you have dispensed room temperature water multiple times and <b>E2</b> is still displayed, don't hesitate to contact iSpring.
<b>E3</b>	Abnormal water level in pure water pitcher.	Please contact iSpring Customer Service.
<b>E4</b>	Inlet water temperature sensor failure.	Please contact iSpring Customer Service.
<b>E5</b>	Outlet water temperature sensor failure.	Please contact iSpring Customer Service.
<b>E6</b>	It takes over 15 seconds to start heating, but the water temperature does not rise by more than 40°F.	Please contact iSpring Customer Service.
<b>E7</b>	Communication failure between the display and the system.	Please contact iSpring Customer Service.
<b>H1</b>	In standby mode, the room water temperature sensor detected < 35°F.	Automatically clear when temperature > 35°F.

If you have any questions or concerns during the installation and operation, don't hesitate to contact us at [support@ispringwater.com](mailto:support@ispringwater.com) or visit our help page at [ispringwater.com/support](https://ispringwater.com/support).





**Like our products?**

**Please show your support by writing a product review on the market place where you make your purchase. Even just a quick statement means a lot to us.**

**Thank you!**

**iSpringWater.com**



**Scan to get your FREE warranty**

**For questions, comments, or technical support, please contact us at:**

**✉ support@ispringwater.com**

**☎ +1 (678) 261-7611**

**💬 +1 (470) 560-0012**

**Monday-Friday 9:00 a.m. - 5:00 p.m. EST**

**Water's Good®**